

BNC to 4-Pin Threaded M8/Pico-Style Cordsets with Shield

Cable: PVC jacket, PUR (polyurethane) connector body, nickel-plated brass coupling nut on QD end
Conductors: 26 AWG
Voltage/Current Rating: 125V ac/125V dc, 4.0 A
Temperature: -40° to +105° C **Environmental Rating:** IP67

Style	Length	Model	Cable Diameter	Dimensions (mm)	Pinout	Used With
BNC/ Pico QD Straight	2.00 m	PKG4M-2/CS	4.40 mm		<p>Female</p> <p>1 = Brown 3 = Blue 2 = Not Used 4 = Drain</p> <p>Male</p>	• IP68 Sealed P4
	5.00 m	PKG4M-5/CS				
	9.00 m	PKG4M-9/CS				

Communication Cordsets

Style	Length	Model	Cable Diameter	Dimensions (mm)	Pinout	Used With
5-Pin M12/ Euro-Style, Straight	1.83 m	MQDMC-506	5.60 mm		<p>Male</p> <p>1 = Brown 2 = White 3 = Blue 4 = Black 5 = Gray</p>	• EZ-ARRAY to INTUSB485-1 USB Serial Adapter
	4.57 m	MQDMC-515				
	9.14 m	MQDMC-530				
5-Pin M12/ Euro-Style, Right-Angle	1.83 m	MQDMC-506RA	5.60 mm		<p>Male</p> <p>1 = Brown 2 = White 3 = Blue 4 = Black 5 = Gray</p>	• EZ-ARRAY to INTUSB485-1 USB Serial Adapter
	4.57 m	MQDMC-515RA				
	9.14 m	MQDMC-530RA				

Accessories

Brackets





Cordsets

Retroreflectors

Miscellaneous

Reference

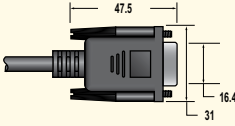
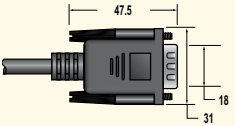
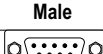
DB9 Communication Cordsets

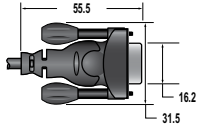
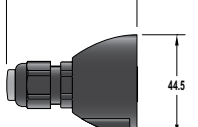
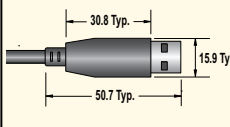
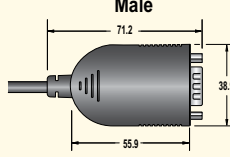
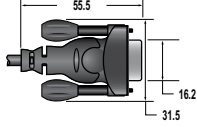
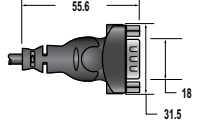
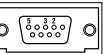
Style	Length	Model	Cable Diameter	Dimensions (mm)		Pinout	Used With
Male DB9/ Female DB9	1.83 m	DB9P06	6.00 mm	Female	Male	Male  Female 	• Pro
	4.57 m	DB9P15					
	9.14 m	DB9P30					
Male DB9/ Female DB9	3.00 m	AG4-PCD9-3	5.00 mm	Female	Male	Male  USB 	• AG4 • AG4 Serial-to USB Adapter
	5.00 m	AG4-PCD9-5					
	10.0 m	AG4-PCD9-10					
Male DB9/USB	1.00 m	AG4-PCD9USB-1	4.6 mm		Male 		
Male DB9/ Female DB9	2.00 m	MASC	5.00 mm		Male 	Female  2 = Transmit (TX) 3 = Receive (RX) 5 = Ground (GRD)	• MINI-ARRAY • High-Resolution MINI-ARRAY

DB15 Configuration/Machine Interface Cordsets

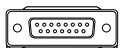
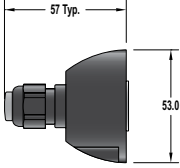
Style	Length	Model	Cable Diameter	Dimensions (mm)	Pinout	Used With
DB15	5.00 m	AG4-CPD15-5	8.50 mm	Female	Female 	• AG4
	10.0 m	AG4-CPD15-10				
	25.0 m	AG4-CPD15-25				
	50.0 m	AG4-CPD15-50				